

Table of contents

Part I Installation

Part I is designed for the technician. It contains information about electrical connections and I.D.E. e1.01 controller installation.

Part II Operating manual

Part II is designed for the user. It contains information about menu configuration and operating cycle.

1. Operating mode	4
2. Programming mode	5
2.1. Default session time	5
2.2. Time delay.....	6
2.3. Advanced functions	6
2.3.1. Counters presentation	7
2.3.2. Protected settings	7
2.3.2.1. Counters	8
Lamps counter 1	9
Lamps counter 2	9
Lamps counter 3	10
Fans counter	10
Time delays counter	11
Paid time counter	11
Clients counter	12
2.3.2.2. Statistics	12
Electric energy counter	12
Takings total counter	13
2.3.2.3. Programming options	14
Step	14
Maximum time delay	15
Maximum session time	15
Ventilation	16
Price	16
Lamps end	17
Lamps power consumption	17
Fans power consumption	18
Stop fans	18
Stop lamps	19
External stop	19
Buzzer	20
2.3.2.4. No code access	20
2.3.2.5. Code change	21

Symbols used in the manual

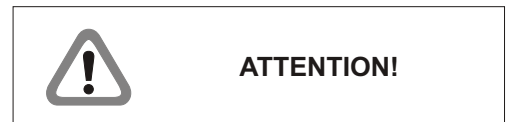
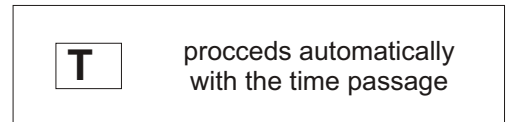
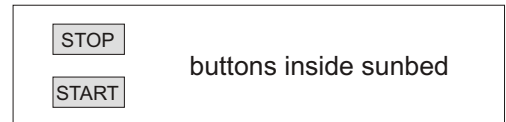

Part I. Installation

The installation of the I.D.E. E1.01 controller should be conducted by the authorized service. The producer does not take any responsibility for any damage or loss resulted from the installation conducted by the unauthorized service.



Disconnect power supply in the sunbed before installation.

Read the sunbed manual to choose the optimal type of connection before preparing electrical connections:

Type A - lamps and/or fans operation control circuit connection (230 V, AC);

Type B - potential free contact connections.

Electrical connection - Type A

1. Prepare the following circuit connections (picture 1). These connections provide power supply for the controller and enable operations on the lamps and fans operation control circuits. Connect the following wires to the sunbed.

- yellow wire 1,0 - lamps operation control circuit (230 V, AC);
- black wire 1,0 - 230 V, AC (the phase supplying the control circuits of the sunbed);
- blue wire 1,0 - neutral (N);
- red wire 1,0 - fans operation control circuit (230 V, AC)



If the sunbed is equipped with the system of automatic ventilation, fans operation control circuit should not be connected. Insulate the red cable properly.

If the sunbed is equipped with the system of automatic ventilation, ventilation time, set in the controller's menu, should be identical with the ventilation time, set inside sunbed.

2. Prepare the following low voltage connections (picture 1). These include the connection of and buttons in the sunbed, operating as normally opened contactors. Connect the following wires to the sunbed.

- red wire 0,5 - external button (*remote stop, quick stop*).
- blue wire 0,5 - external button (*remote start, quick start*);
- black wire 0,5 - 0 V (common wire).



Some sunbeds do not have "remote start" and/or "remote stop" option. Read the sunbed manual before preparing low voltage connections. Wires, if not connected to the sunbed, should be properly insulated.

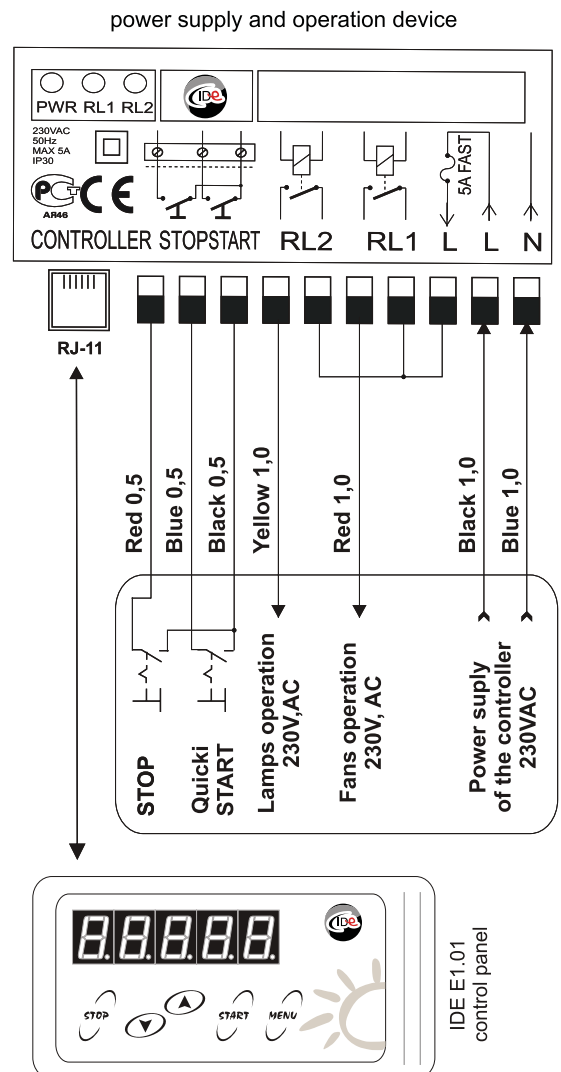

Picture 1. Electrical connection - Type A

Part I. Installation



In case of sunbeds with single button, sky blue and orange wires should be connected together

After the above connections have been made, fasten the I.D.E. E1.01 control panel and connect it to the power supply and operation device.

Electrical connection - Type B



In case of potential free connection, cable bridge with is included to the other cables in plastic bag, can not be connected !

1. Prepare the following circuit connections (picture 2). These connections provide power supply for the controller. Connect the following wires to the sunbed.

black wire - phase (230 V, AC);
blue wire - neutral (N).

2. Prepare the following potential free contact connections (picture 2). These connections enable operations on the sunbed.

yellow wire - potential free contact;
red wire - potential free contact.

3. Prepare the following low voltage connections (picture 2). These include the connection of and buttons in the sunbed, operating as normally opened contactors. Connect the following wires to the sunbed.

red wire 0,5 - external button (*remote stop, quick stop*);
blue wire 0,5 - external button (*remote start, quick start*);
black wire 0,5 - 0V (common wire).



Some sunbeds do not have “remote start” and/or “remote stop” option. Read the sunbed manual before preparing low voltage connections. Wires, if not connected to the sunbed, should be properly insulated.

In case of sunbeds with single button, sky blue and orange wires should be connected together (picture 2).

After the above connections have been made, fasten the I.D.E. E1.01 control panel and connect it to the power supply and operation device.

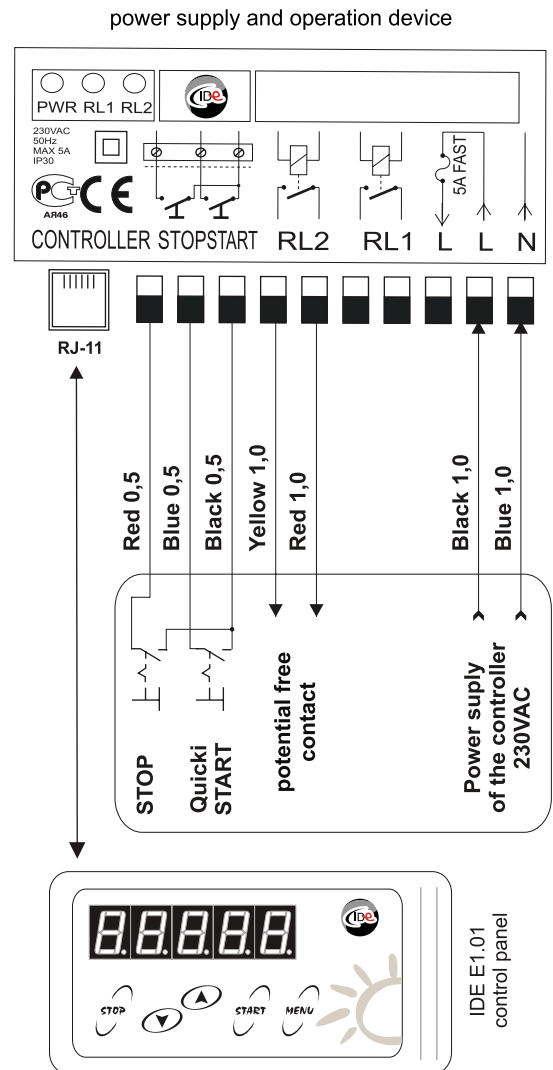

Picture 2. Electrical connection - Type B

Part II Operating manual

1. Operating mode

To turn on sunbed:

1. When the controller is on standby, press **SPR** button. Default session time (see page 5) will be displayed.
2. Set the session time with **▲** and **▼** buttons.
3. Press **SPR** button in the controller. The controller starts counting down time delay (*Time delay*, see page 6). During the time delay there is a possibility of turning on the sunbed with **SPR** button in the controller or with **START** button in the sunbed.



If lamps counter 3 contents exceeds *Lamps end* setting (see page 17), the controller during the session signals with sound signal the necessity of changing lamps.

If time delay set value is “zero”, lamps and fans will be turned on after pressing **SPR** button in the controller.

4. After the passage of the time delay, pressing **SPR** button in the controller, or pressing **START** button in the sunbed, the controller turns on lamps and fans and starts counting down session time.



If *External stop* option is activated (see page 19), there is a possibility of turning off the lamps for a while with **STOP** button in the sunbed (session symbol will start blinking) and restarting them with **START** button.

If *Stop lamps* option is activated (see page 19), there is a possibility of turning off the lamps (end of session) with **SEP** button in the controller.

5. After the passage of the session time, the controller turns off the lamps and starts counting down ventilation time.



If *Stop fans* option is activated (see page 18), there is a possibility of turning off the fans (end of ventilation) with **SEP** button in the controller.

6. After the passage of the ventilation time, the controller passes to the standby mode. The controller is ready to resume the sunbed or to enter changes in the controller’s menu.

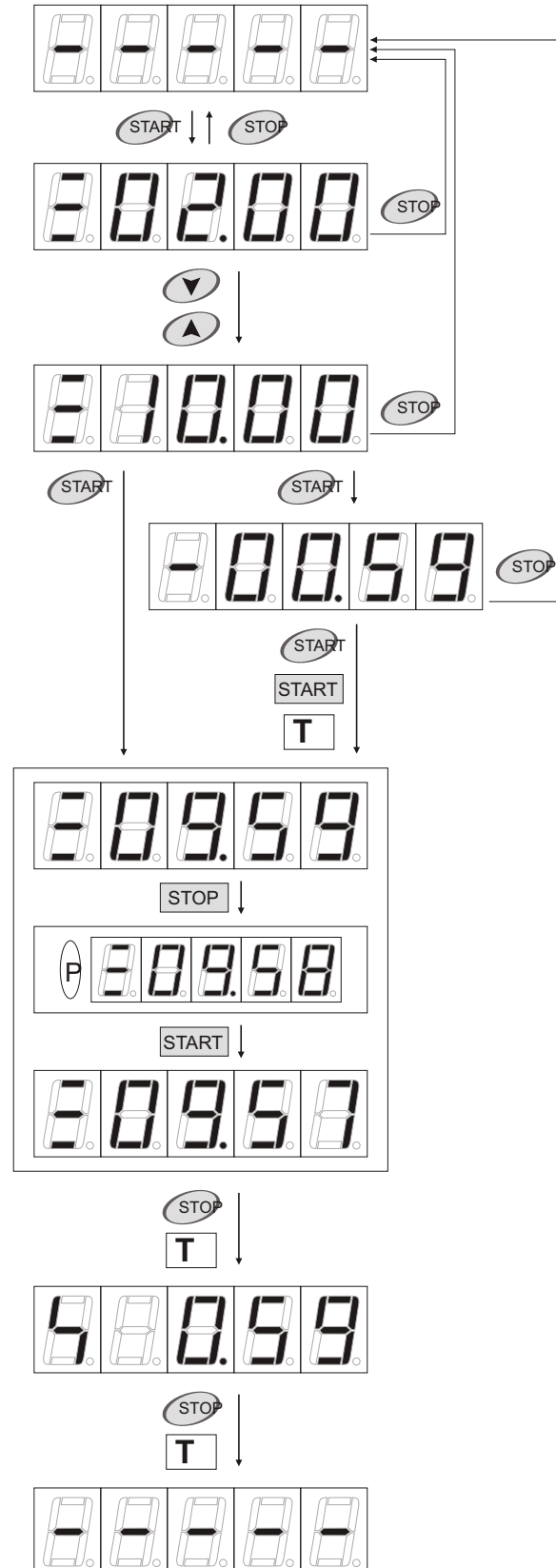

Part II Operating manual

2. Programming mode

Changes in the controller's menu settings are executed in the programming mode. Controller's main menu is protected by the code, which prevents from entering the unauthorized changes. There are two options in the main menu:

- Default session time (see page 5);
- Time delay (see page 6);
- and Advanced functions submenu (see page 6).

To access programming mode, press **MBU** button in the controller on standby. Default session time will be displayed (see page 6).

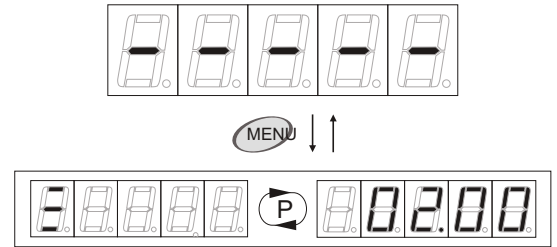

Buttons functions in the programming mode

SFR - "step forward". Button is used to enter submenu, start editing particular options and counters, and to confirm changes in the temporary memory;

SCP - "step backward". Button is used for leaving submenu and leaving the edited option or counter, and to confirm changes in the temporary memory;

▲ and **▼** - buttons are used to change the parameters values and to select particular option or submenu.

MBU - button is active only on standby. It is used for entering and leaving controller's menu and saving changes in the long term memory.



After the changes have been entered in the controller's menu, it is necessary to leave the menu with **MBU** button, to save the changes in the long term memory. The controller returns to the standby mode automatically, saving all the changes in the long term memory, when non active for more than 60 seconds.

2.1. Default session time

Default session time option is used is to set the most frequent operation time of the given sunbed. Default session time is used in the operating mode (see page 4).

- Range of setting: < 01.00 ; 60.00 > (min)
- Default setting: 02.00
- Step: < 01.00 ; 10.00 > (min) - see page 14

To browse and/or change default session time:
 1. When the controller is in the programming mode (see page 5), select *Default session time* option with **▲** and **▼** buttons. The tanning symbol and the default session time setting is displayed alternately.

2. To change the setting, press **SFR** button. Default session time setting will be displayed.

3. Set new value with **▲** and **▼** buttons.

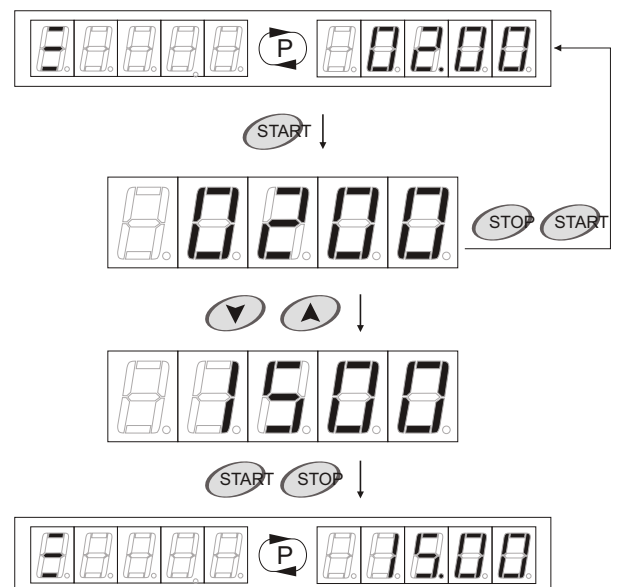

Part II Operating manual

2. Programming mode

4. To save new setting in the temporary memory, press **SPRT** or **SCP** buttons.

To leave the programming mode and save new setting in the long term memory, press **MENU** button or wait 60 seconds.

2.2. Time delay

Time delay is the time necessary for the client to prepare for session. The time delay is counted down from the moment of pressing **SPRT** button in the controller, confirming the set session time. During the time delay it is possible to turn on the lamps with **SPRT** in the controller or **START** button in the sunbed. After the passage of the time delay, the sunbed turns on automatically.

Range of setting: < 00.00 ; 60.00 > (min)

Default setting: 01.00

Step: 15 sec



If time delay set value is "zero", lamps and fans will be turned on after pressing **SPRT** button in the controller.

To browse and/or change time delay:

1. When the controller is in the programming mode (see page 5), select *Time delay* option with **▲** and **▼** buttons. The time delay symbol and the time delay setting is displayed alternately.

2. To change the setting, press **SPRT** button. Time delay setting will be displayed.

3. Set new value with **▲** and **▼** buttons.

4. To save new setting in the temporary memory, press **SPRT** or **SCP** buttons.

To leave the programming mode and save new setting in the long term memory, press **MENU** button or wait 60 seconds.

2.3. Advanced functions

There are two submenus in the *Advanced functions* submenu: *Protected settings*, which access to requires entering the code; and *Counters presentation*.

To access *Advanced functions* submenu:

1. When the controller is in the programming mode (see page 5), select *Advanced functions* submenu with **▲** and **▼** buttons.

2. Press **SPRT** button. *Counters presentation* submenu will be displayed.

To leave the programming mode, press **MENU** button or wait 60 seconds.

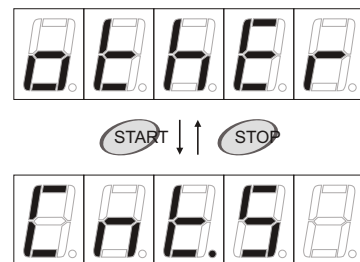
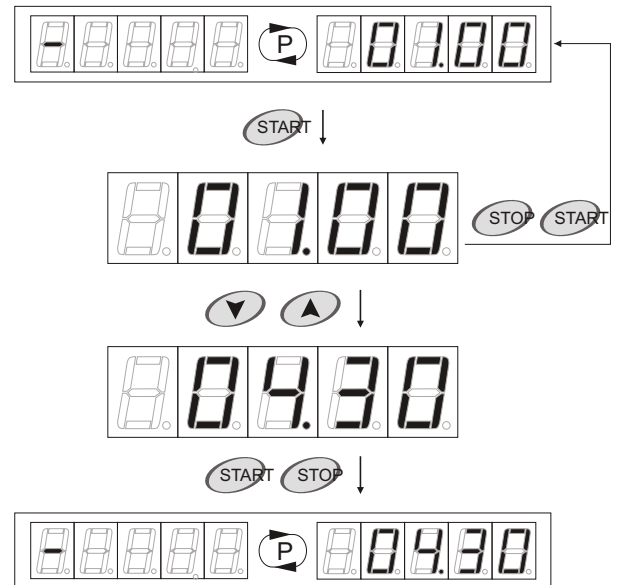

Part II Operating manual

2. Programming mode

2.3.1. Counters presentation 07651

The controller has 9 counters. In the *Counters presentation* submenu it is only possible to browse the contents of the following counters:

- Lamps counter 1 (see page 9);
- Lamps counter 2 (see page 9);
- Lamps counter 3 (see page 10);
- Fans counter (see page 10);
- Time delays counter (see page 11);
- Paid time counter (see page 11);
- Clients counter (see page 12);
- Electric energy counter (see page 12);
- Takings total counter (see page 13).



In the *Counters presentation* submenu it is possible to browse the counters, which were activated in the *No code access* submenu (see page 20).

All counters are also available in the *Counters* submenu (see page 8) and *Statistics* submenu (see page 12). In these submenus it is possible to browse and delete counters contents.

To browse the contents of the accessible counters:

1. When the controller is in the programming mode (see page 5), in the *Counters presentation* submenu, select accessible counter with and buttons. The selected counter symbol and its contents is displayed alternately.

2. Press button. The selected counter symbol and its contents, expressed in minutes, is displayed alternately.

To return to the *Advanced functions* submenu (see page 6), press button. To leave the programming mode, press button or wait 60 seconds.



Step 2. does not apply to clients counter, electric energy counter and takings total counter.

2.3.2. Protected settings 00000

There are 5 submeuns in the *Protected settings* submenu, which access to requires entering the code:

- Counters (see page 8);
- Statistics (see page 12);
- Programming options (see page 14)
- No code access (see page 20);
- Code change (see page 21).

All new controllers have producer's code (00000), which should be changed by the sunbed owner (*Code change*, see page 21), which prevents from entering the unauthorized changes in the controller's menu.

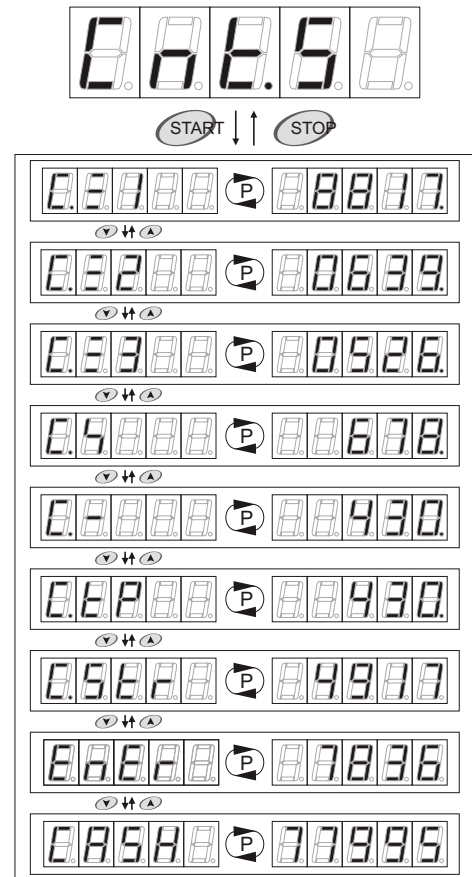

Part II Operating manual

2. Programming mode

To access *Protected settings* submenu:

1. When the controller is in the programming mode (see page 5), in the *Advanced functions* submenu (see page 6), select *Protected settings* submenu with and buttons.

2. Press button. Enter the code with and buttons, confirming each number with .



If the entered code is proper, *Counters* submenu will be displayed (see page 8). If the entered code is wrong, will be displayed for a while. In such a case it is necessarily to repeat entering the code.

To return to the *Advanced functions* submenu, press button. To leave the programming mode, press button or wait 60 seconds.

2.3.2.1. Counters

In the *Counters* submenu (see page 8) it is possible to browse and delete the following counters:

- Lamps counter 1* (see page 9);
- Lamps counter 2* (see page 9);
- Lamps counter 3* (see page 10);
- Fans counter* (see page 10);
- Time delays counter* (see page 11);
- Paid time counter* (see page 11);
- Clients counter* (see page 12).

To access *Counters* submenu:

1. When the controller is in the programming mode (see page 5), in the *Protected settings* submenu (see page 7), select *Counters* submenu with and buttons.

2. Press button.

To return to the *Protected settings* submenu, press button. To leave the programming mode, press button or wait 60 seconds.

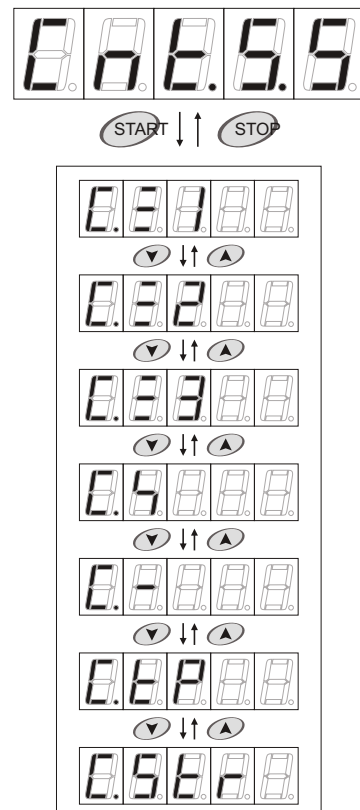
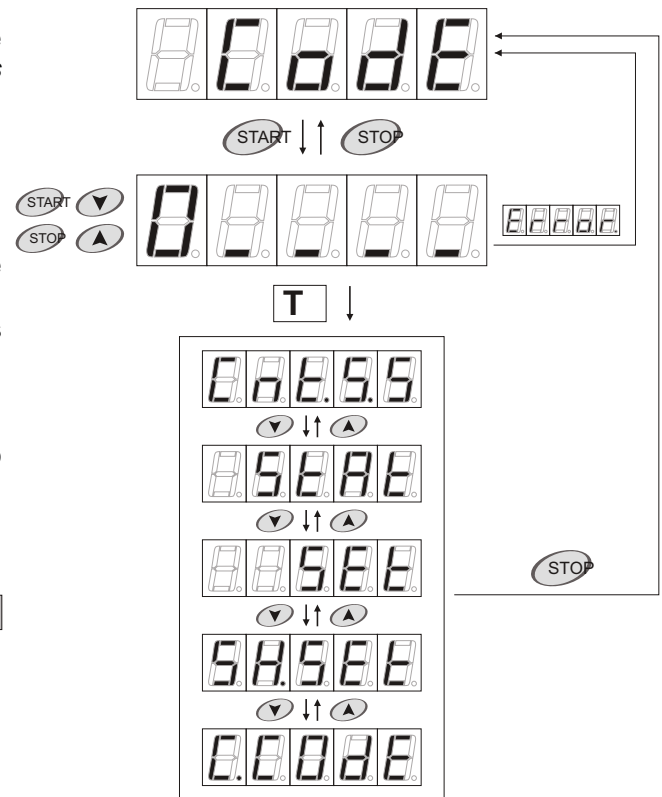

Part II Operating manual

2. Programming mode

Lamps counter 1

Lamps counter 1 (undeletable) shows real lamps operation time since the installation.

Counter's capacity: <0000h00m ; 9999h59m >
 Default setting: 0000h00m

To browse lamps counter 1 contents:

1. When the controller is in the programming mode (see page 5), in the *Counters* submenu (see page 8), select lamps counter 1 with and buttons. Lamps counter 1 symbol and its contents, expressed in hours, is displayed alternately.

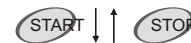
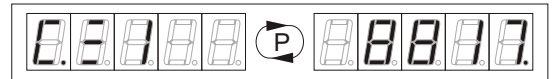

2. Press button. Lamps counter 1 symbol and its contents, expressed in minutes, is displayed alternately.

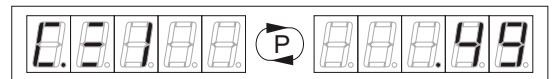

To return to the *Counters* submenu, press button. To leave the programming mode, press button or wait 60 seconds.

The changes of the counter's contents are saved automatically in the long term memory after each minute,

Lamps counter 2

Lamps counter 2 (deletable) shows real lamps operation time since the last deleting.

Counter's capacity: <0000h00m ; 9999h59m >
 Default setting: 0000h00m

To browse and/or delete lamps counter 2 contents:

1. When the controller is in the programming mode (see page 5), in the *Counters* submenu (see page 8), select lamps counter 2 with and buttons. Lamps counter 2 symbol and its contents, expressed in hours, is displayed alternately.

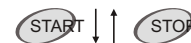
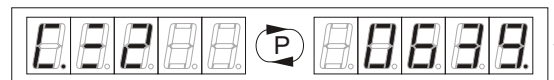

2. Press button. Lamps counter 2 symbol and its contents, expressed in minutes, is displayed alternately.

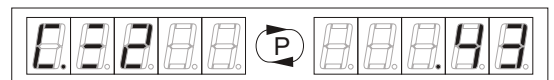

3. To delete lamps counter 2 contents, press button.

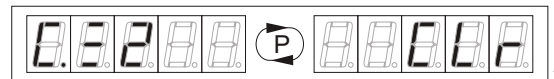

4. To delete lamps counter 2 contents, press button. To stop deleting counter's contents, press button.



To return to the *Counters* submenu, press button. To leave the programming mode, press button or wait 60 seconds.

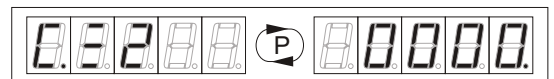

The changes of the counter's contents are saved automatically in the long term memory after each minute,

Part II Operating manual

2. Programming mode

Lamps counter 3

Lamps counter 3 (deletable) shows real lamps operation time since the last deleting.

Counter's capacity: <0000h00m ; 9999h59m >
 Default setting: 0000h00m

To browse and/or delete lamps counter 3 contents:

1. When the controller is in the programming mode (see page 5), in the *Counters* submenu (see page 8), select lamps counter 3 with and buttons. Lamps counter 3 symbol and its contents, expressed in hours, is displayed alternately.

2. Press button. Lamps counter 3 symbol and its contents, expressed in minutes, is displayed alternately.

3. To delete lamps counter 3 contents, press button.

4. To delete lamps counter 3 contents, press button. To stop deleting counter's contents, press button.

To return to the *Counters* submenu, press button. To leave the programming mode, press button or wait 60 seconds.

The changes of the counter's contents are saved automatically in the long term memory after each minute, during the session.

Fans counter

Fans counter (deletable) shows real fans operation time since the last deleting.

Counter's capacity: <0000h00m ; 9999h59m >
 Default setting: 0000h00m

To browse and/or delete fans counter contents:

1. When the controller is in the programming mode (see page 5), in the *Counters* submenu (see page 8), select fans counter with and buttons. Fans counter symbol and its contents, expressed in hours, is displayed alternately.

2. Press button. Fans counter symbol and its contents, expressed in minutes, is displayed alternately.

3. To delete fans counter contents, press button.

4. To delete fans counter contents, press button. To stop deleting counter's contents, press button.

To return to the *Counters* submenu, press button. To leave the programming mode, press button or wait 60 seconds.

The changes of the counter's contents are saved automatically in the long term memory after each minute, during the session.

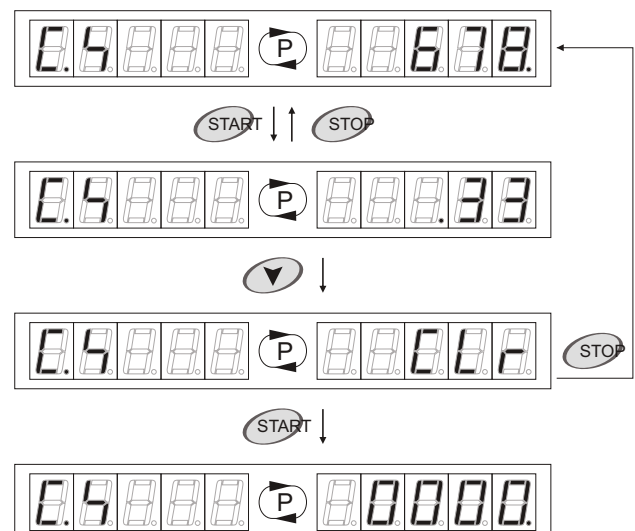
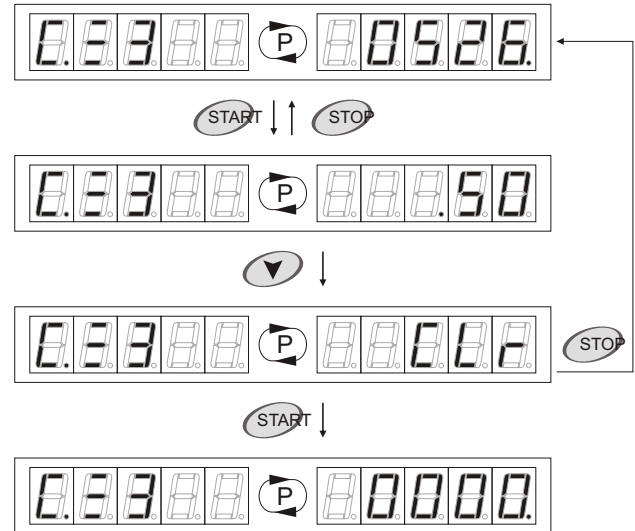

Part II Operating manual



2. Programming mode

Time delays counter

Time delays counter (deletable) shows total time delays since the last deleting.



Counter's capacity: <0000h00m ; 9999h59m >
 Default setting: 0000h00m



To browse and/or delete time delays counter contents:

1. When the controller is in the programming mode (see page 5), in the *Counters* submenu (see page 8), select time delays counter with  and  buttons. Time delays counter symbol and its contents, expressed in hours, is displayed alternately.

2. Press  button. Time delays counter symbol and its contents, expressed in minutes, is displayed alternately.

3. To delete time delays counter contents, press  button.

4. To delete time delays counter contents, press  button. To stop deleting counter's contents, press  button.

To return to the *Counters* submenu, press  button. To leave the programming mode, press  button or wait 60 seconds.





The changes of the counter's contents are saved automatically in the long term memory after the of ventilation.

Paid time counter

Paid time counter (deletable) shows the total sessions time, set by the user, since the last deleting.

Counter's capacity: <0000h00m ; 9999h59m >
 Default setting: 0000h00m



To browse and/or delete paid time counter contents:

1. When the controller is in the programming mode (see page 5), in the *Counters* submenu (see page 8), select paid time counter with  and  buttons. Paid time counter symbol and its contents, expressed in hours, is displayed alternately.

2. Press  button. Paid time counter symbol and its contents, expressed in minutes, is displayed alternately.

3. To delete paid time counter contents, press  button.

4. To delete paid time counter contents, press  button. To stop deleting counter's contents, press  button.

To return to the *Counters* submenu, press  button. To leave the programming mode, press  button or wait 60 seconds.



The changes of the counter's contents are saved automatically in the long term memory at the beginning of the session.

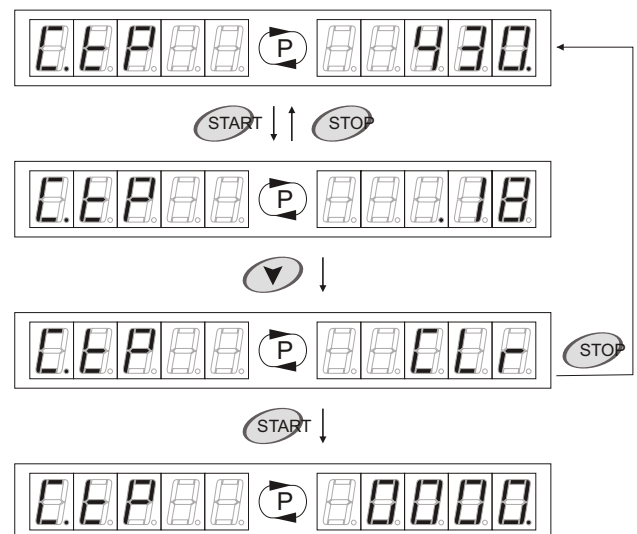
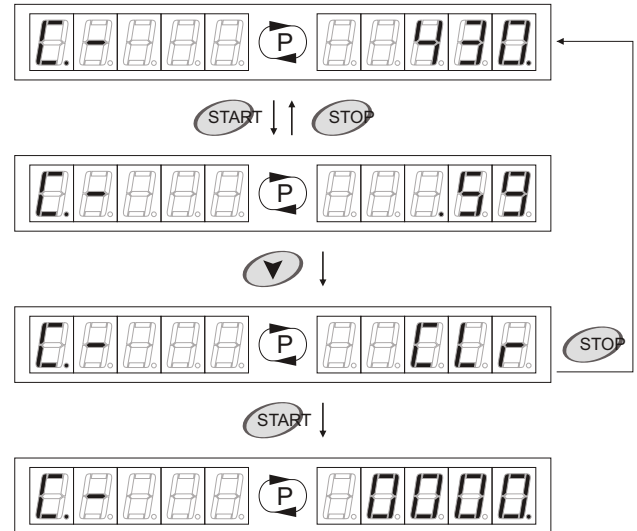

Part II Operating manual

2. Programming mode

Clients counter 05877

Clients counter (deletable) shows the total operating cycles since the last deleting.

Counter's capacity: <0000 ; 9999 >
 Default setting: 0000

To browse and/or delete clients counter contents:

1. When the controller is in the programming mode (see page 5), in the *Counters* submenu (see page 8), select clients counter with and buttons. Clients counter symbol and its contents, is displayed alternately.

2. To delete clients counter contents, press button.

3. To delete clients counter contents, press button again. To stop deleting counter's contents, press button.

To return to the *Counters* submenu, press button. To leave the programming mode, press button or wait 60 seconds.



The changes of the counter's contents are saved automatically in the long term memory at the beginning of the session.

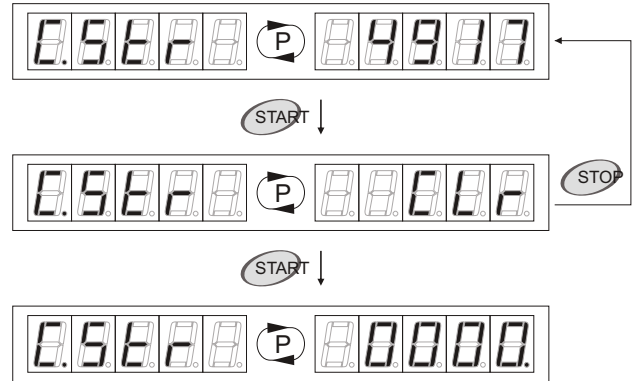

2.3.2.2. Statistics 15877

In the *Statistics* submenu (see page 12) it is possible to browse and delete the following counters:

Electric energy counter (see page 12);
Takings total counter (see page 13).

To access *Statistics* submenu:

1. When the controller is in the programming mode (see page 5), in the *Protected settings* submenu (see page 7), select *Statistics* submenu with and buttons.

2. Press button.

To return to the *Protected settings* submenu, press button. To leave the programming mode, press button or wait 60 seconds.

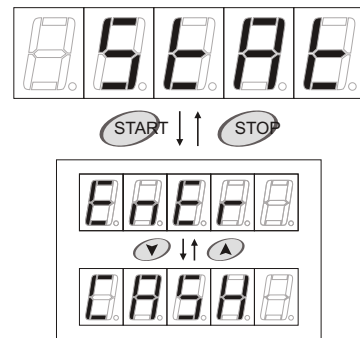

Electric energy counter 00000

Electric energy counter (deletable) shows total power consumption since the last deleting.

Counter's capacity: <00000 ; 99999 > kWh
 Default setting: 00000



Electric energy counter contents are calculated on the basis of values set in *Lamps power consumption* (see page 17) and *Fans power consumption* (see page 18) options.

Part II Operating manual

2. Programming mode

To browse and/or delete electric energy counter contents:

1. When the controller is in the programming mode (see page 5), in the *Statistics* submenu (see page 12), select electric energy counter with and buttons. Electric energy counter symbol and its contents, expressed in kWh, is displayed alternately.

2. To delete electric energy counter contents, press button.

3. To delete electric energy counter contents, press button again. To stop deleting counter's contents, press button.

To return to the *Statistics* submenu, press button. To leave the programming mode, press button or wait 60 seconds.



The changes of the counter's contents are saved automatically in the long term memory at the beginning of the session.

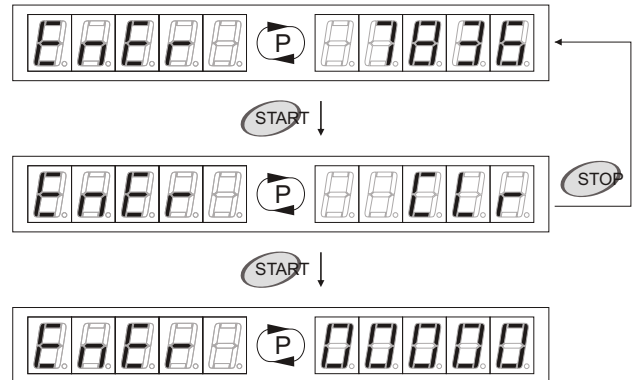

Takings total counter

Takings total counter (deletable) shows the expected income since the last deleting.

Counter's capacity: <00000 ; 99999 >
 Default setting: 00000



Takings total counter contents are calculated on the basis of values set in *Price* option (see page 16).

To browse and/or delete takings total counter contents:

1. When the controller is in the programming mode (see page 5), in the *Statistics* submenu (see page 12), select takings total counter with and buttons. Takings total counter symbol and its contents, expressed in the user's currency, is displayed alternately.

2. To delete takings total counter contents, press button.

3. To delete takings total counter contents, press button again. To stop deleting counter's contents, press button.

To return to the *Statistics* submenu, press button. To leave the programming mode, press button or wait 60 seconds.



The changes of the counter's contents are saved automatically in the long term memory at the beginning of the session.

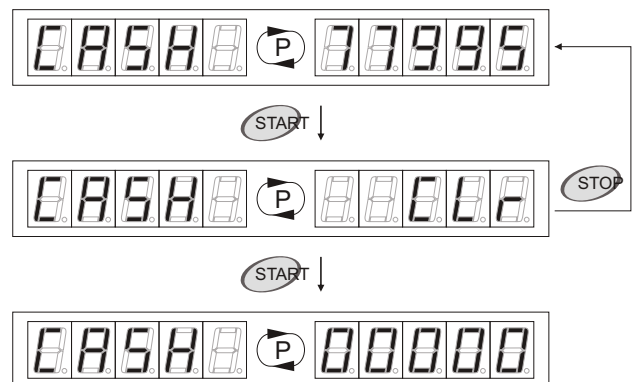

Part II Operating manual

2. Programming mode

2.1.2. Programming options SEEF

In the *Programming options* submenu (see page 14) it is possible to browse and change the following options:

- Step (see page 14);
- Maximum time delay (see page 15);
- Maximum session time (see page 15);
- Ventilation (see page 16);
- Price (see page 16);
- Lamps end (see page 17);
- Lamps power consumption (see page 17);
- Fans power consumption (see page 18);
- Stop fans (see page 18);
- Stop lamps (see page 19);
- External stop (see page 19);
- Buzzer (see page 20);

To access *Programming options* submenu:

1. When the controller is in the programming mode (see page 5), in the *Protected settings* submenu (see page 7), select *Programming options* submenu with ▲ and ▼ buttons.

2. Press SPRT button.

To return to the *Protected settings* submenu, press SCP button. To leave the programming mode, press MENU button or wait 60 seconds.

Step SEEF

Option is used for setting the session time (*Operating mode*, see page 4). Each ▲ button pressing increases the session time with *Step* value. Each ▼ button pressing decreases the session time with *Step* value.

- Range of setting: < 01.00 ; 10.00 > (min)
- Default setting: 01.00
- Step: 1 min

To browse and/or change step:

1. When the controller is in the programming mode (see page 5), in the *Programming options* submenu (see page 14), select *Step* option with ▲ and ▼ buttons. The step symbol and step setting is displayed alternately.

2. To change the setting, press SPRT button. Step setting will be displayed.

3. Set new value with ▲ and ▼ buttons.

4. To save new setting in the temporary memory, press SPRT or SCP buttons.

To return to the *Programming options* submenu, press SCP button. To leave the programming mode, press MENU button or wait 60 seconds.

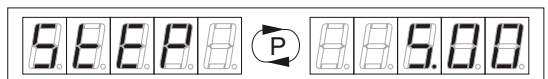
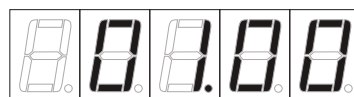
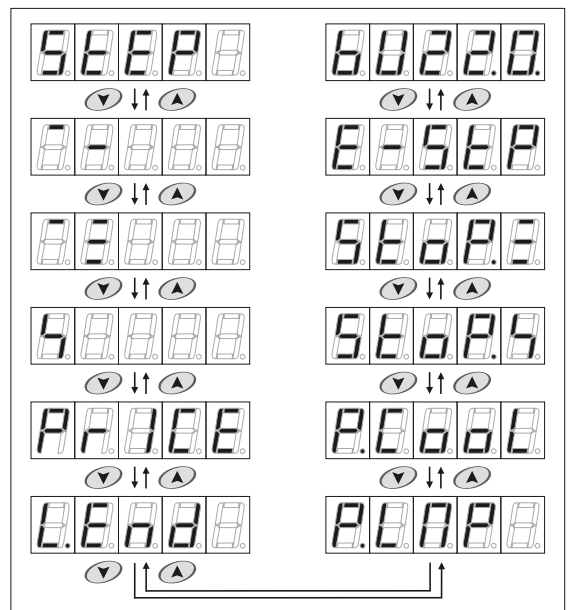
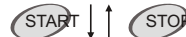
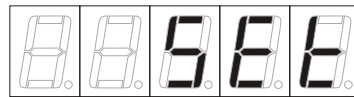

Part II Operating manual

2. Programming mode

Maximum time delay [] [] [] [] []

Maximum time delay is the maximum time delay value (*Time delay*, see page 6), that can be set in the operating mode (see page 4).

Range of setting: 00 ; 20.00 > (min)
 Default setting: 20.00
 Step: 10 sec

To browse and/or change maximum time delay:

1. When the controller is in the programming mode (see page 5), in the *Programming options* submenu (see page 14), select *Maximum time delay* option with ▲ and ▼ buttons. The maximum time delay symbol and the maximum time delay setting is displayed alternately.

2. To change the setting, press **SPRT** button. Maximum time delay setting will be displayed.

3. Set new value with ▲ and ▼ buttons.

4. To save new setting in the temporary memory, press **SEPT** or **SEPT** buttons.

To return to the *Programming options* submenu, press **SEP** button. To leave the programming mode and save new setting in the long term memory, press **MBU** button or wait 60 seconds.

Maximum session time [] [] [] [] []

Maximum session time is the maximum time of single session, that can be set in the operating mode (see page 4).

Range of setting: 00 ; 60.00 > (min)
 Default setting: 60.00
 Step: 1 min

To browse and/or change maximum session time:

1. When the controller is in the programming mode (see page 5), in the *Programming options* submenu (see page 14), select *Maximum session time* option with ▲ and ▼ buttons. The maximum session time symbol and the maximum session time setting is displayed alternately.

2. To change the setting, press **SPRT** button. Maximum session time setting will be displayed.

3. Set new value with ▲ and ▼ buttons.

4. To save new setting in the temporary memory, press **SEPT** or **SEPT** buttons.

To return to the *Programming options* submenu, press **SEP** button. To leave the programming mode and save new setting in the long term memory, press **MBU** button or wait 60 seconds.

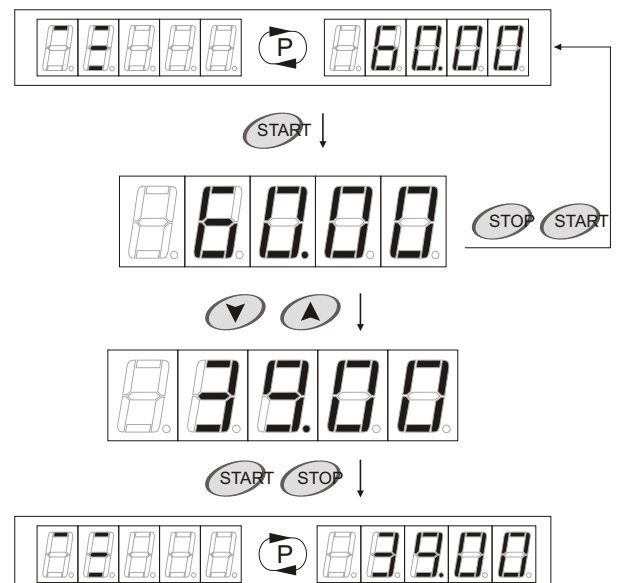
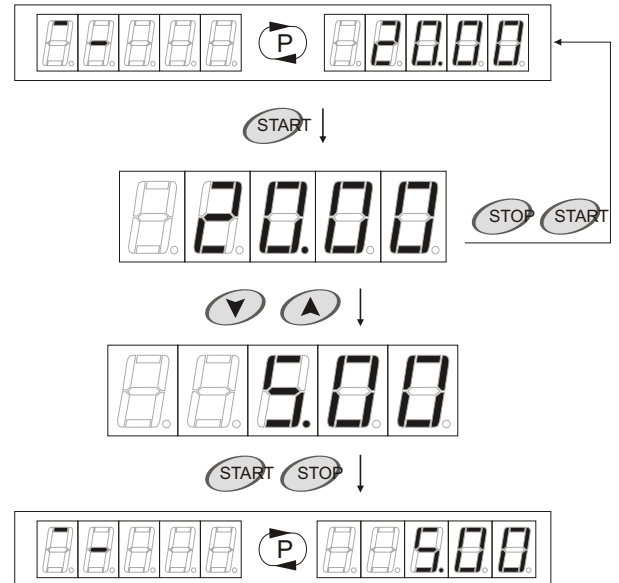

Part II Operating manual

2. Programming mode

Ventilation

Option is used to set fans operating time after the session.

Range of setting: < 00.00 ; 20.00 > (min)



Default setting: 01.00

Step: 10 sec





If the sunbed is equipped with the system of automatic ventilation, ventilation time, set in the controller's menu, should be identical with the ventilation time, set inside sunbed.



To browse and/or change ventilation time:

1. When the controller is in the programming mode (see page 5), in the *Programming options* submenu (see page 14), select *Ventilation* option with  and  buttons. The ventilation symbol and the ventilation time is displayed alternately.

2. To change the setting, press  button. Ventilation time will be displayed.

3. Set new value with  and  buttons.

4. To save new setting in the temporary memory, press  or  buttons.

To return to the *Programming options* submenu, press  button. To leave the programming mode and save new setting in the long term memory, press  button or wait 60 seconds.

Price



Option is used to set the price for one minute of session, according to which the controller will calculate the takings total counter contents (see page 13).

Range of setting: < 00.00 ; 99.90 >

Default setting: 00.00



Step: 00.10



To browse and/or change price setting:

1. When the controller is in the programming mode (see page 5), in the *Programming options* submenu (see page 14), select *Price* option with  and  buttons. The price symbol and the price setting is displayed alternately.

2. To change the setting, press  button. Price setting will be displayed.

3. Set new value with  and  buttons.

4. To save new setting in the temporary memory, press  or  buttons.

To return to the *Programming options* submenu, press  button. To leave the programming mode and save new setting in the long term memory, press  button or wait 60 seconds.

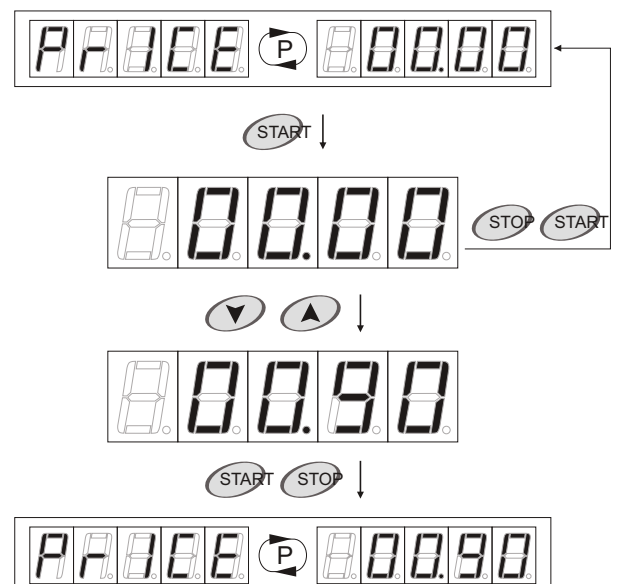
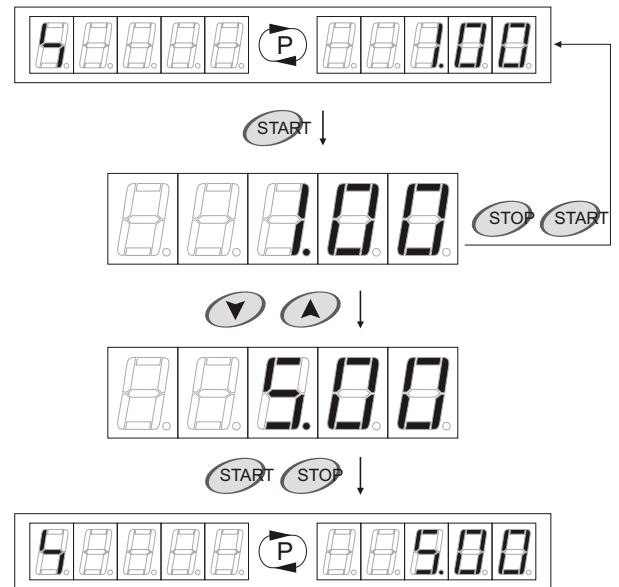

Part II Operating manual

2. Programming mode

Lamps end L E P P

Option is used to set time, after which the lamps in the sunbed should be changed.

Range of setting: off - option deactivated < 10 ; 2550 > (h)
 Default setting: off - option deactivated
 Step: 10 h



When lamps counter 3 (see page 10) contents exceeds lamps end setting, the controller during session signals with sound signal the necessity of changing lamps.

To browse and/or change lamps end setting:

1. When the controller is in the programming mode (see page 5), in the *Programming options* submenu (see page 14), select *Lamps end* option with and buttons. The lamps end symbol and the lamps end setting is displayed alternately.

2. To change the setting, press button. Lamps end setting will be displayed.

3. Set new value with and buttons.

4. To save new setting in the temporary memory, press or buttons.

To return to the *Programming options* submenu, press button. To leave the programming mode and save new setting in the long term memory, press button or wait 60 seconds.

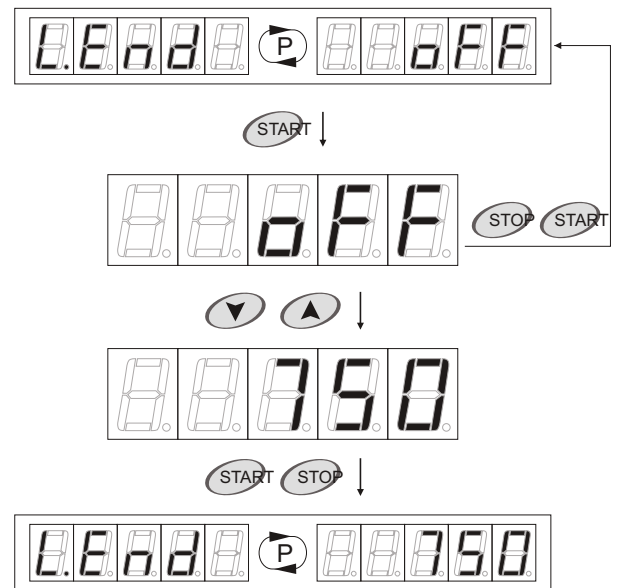

Lamps power consumption P L P P

Option is used to set the value, according to which the controller will calculate the electric energy counter contents (see page 12).

Range of setting: < 00.00 ; 50.00 > (kWh)
 Default setting: 00.00
 Step: 00.05 kWh



If the sunbed is equipped with additional devices (for instance air conditioning), their power consumption should be added to the total body and face lamps power consumption.

To browse and/or change lamps power consumption setting:

1. When the controller is in the programming mode (see page 5), in the *Programming options* submenu (see page 14), select *Lamps power consumption* option with and buttons. The lamps power consumption symbol and the lamps power consumption setting is displayed alternately.

2. To change the setting, press button. Lamps power consumption setting will be displayed.

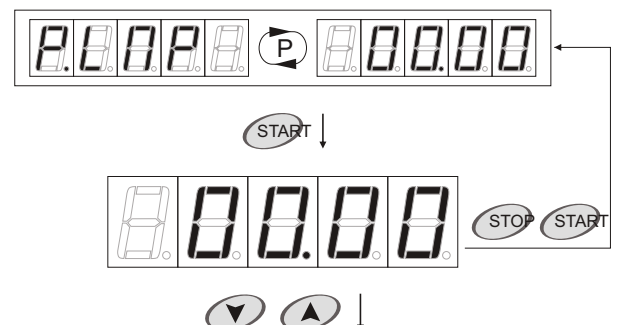

Part II Operating manual

2. Programming mode

3. Set new value with ▲ and ▼ buttons.

4. To save new setting in the temporary memory, press **SPRT** or **SEP** buttons.

To return to the *Programming options* submenu, press **SEP** button. To leave the programming mode and save new setting in the long term memory, press **MBU** button or wait 60 seconds.

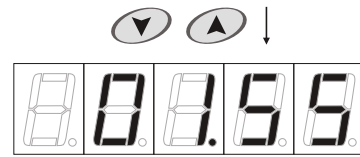

Fans power consumption P0000

Option is used to set the value, according to which the controller will calculate the electric energy counter contents (see page 12).

Range of setting: < 00.00 ; 50.00 > (kWh)
 Default setting: 00.00
 Step: 00.05 kWh

To browse and/or change fans power consumption setting:

1. When the controller is in the programming mode (see page 5), in the *Programming options* submenu (see page 14), select *Fans power consumption* option with ▲ and ▼ buttons. The fans power consumption symbol and the fans power consumption setting is displayed alternately.

2. To change the setting, press **SPRT** button. Fans power consumption setting will be displayed.

3. Set new value with ▲ and ▼ buttons.

4. To save new setting in the temporary memory, press **SPRT** or **SEP** buttons.

To return to the *Programming options* submenu, press **SEP** button. To leave the programming mode and save new setting in the long term memory, press **MBU** button or wait 60 seconds.

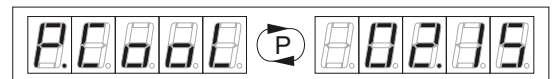
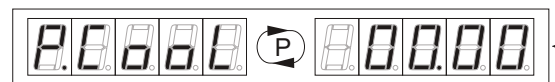

Stop fans SE000

Activating *Stop fans* option allows to turn off the fans during the ventilation with **SEP** button in the controller (end of ventilation).

Range of setting: no - option deactivated;
 yes - option activated
 Default setting: no



Does not apply to sunbeds with the system of automatic ventilation.

To browse and/or change stop fans setting:

1. When the controller is in the programming mode (see page 5), in the *Programming options* submenu (see page 14), select *Stop fans* option with ▲ and ▼ buttons. The stop fans symbol and the stop fans setting is displayed alternately.

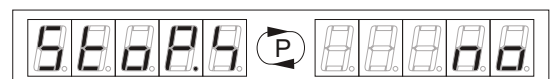

Part II Operating manual

2. Programming mode

2. To change the setting, press **SPR** button. The stop fans symbol and the stop fans new setting is displayed alternately.

To return to the *Programming options* submenu, press **SP** button. To leave the programming mode and save new setting in the long term memory, press **MBU** button or wait 60 seconds.

Stop lamps **SEEP**

Activating *Stop lamps* option allows to turn off the lamps during the session with **SP** button in the controller (end of session).

Range of setting: no - option deactivated;
yes - option activated

Default setting: no

To browse and/or change stop lamps setting:

1. When the controller is in the programming mode (see page 5), in the *Programming options* submenu (see page 14), select *Stop lamps* option with **▲** and **▼** buttons. The stop lamps symbol and the stop lamps setting is displayed alternately.

2. To change the setting, press **SPR** button. The stop lamps symbol and the stop lamps new setting is displayed alternately.

To return to the *Programming options* submenu, press **SP** button. To leave the programming mode and save new setting in the long term memory, press **MBU** button or wait 60 seconds.

External stop **ESPP**

Activating *External stop* option allows to turn off the lamps for a while during the session with **STOP** button in the sunbed and restart them with **START** button.

Range of setting: no - option deactivated;
yes - option activated

Default setting: yes



During the session, tanning symbol is displayed. If *External stop* option is activated, and the lamps are turned off with **STOP** button in the sunbed, the session symbol will start blinking - the controller keeps counting down the session time.

To browse and/or change external stop setting:

1. When the controller is in the programming mode (see page 5), in the *Programming options* submenu (see page 14), select *External stop* option with **▲** and **▼** buttons. The external stop symbol and the external stop setting is displayed alternately.

2. To change the setting, press **SPR** button. The external stop symbol and the external stop new setting is displayed alternately.

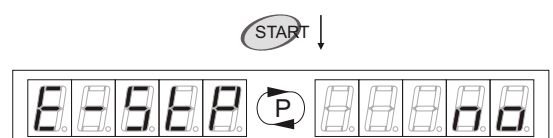
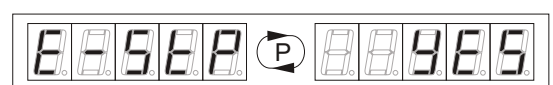
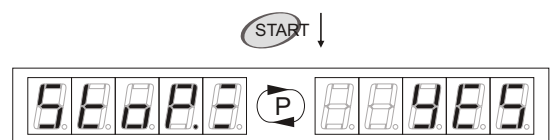
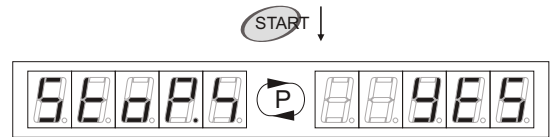

Part II Operating manual

2. Programming mode

To return to the *Programming options* submenu, press **SP** button. To leave the programming mode and save new setting in the long term memory, press **MBU** button or wait 60 seconds.



In a case of changing the external stop setting from “no” into “yes”, reset the controller by turning off and on the power supply.

Buzzer 00220

Option is used to turn on and off sound signals in the controller. Buzzer signals each button pressing in the controller and the end of ventilation with sound signal.

Range of setting: no - option deactivated;
yes - option activated
Default setting: yes

To browse and/or change buzzer setting:

1. When the controller is in the programming mode (see page 5), in the *Programming options* submenu (see page 14), select *Buzzer* option with **▲** and **▼** buttons. The buzzer symbol and the buzzer setting is displayed alternately.



2. To change the setting, press **SP** button. The buzzer symbol and the buzzer new setting is displayed alternately.

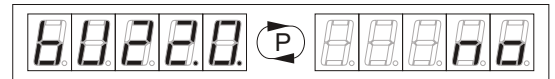

To return to the *Programming options* submenu, press **SP** button. To leave the programming mode and save new setting in the long term memory, press **MBU** button or wait 60 seconds.

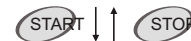

2.3.3. No code access 545555

In the *No code access* submenu it is possible to browse and change the accessibility of the following counters:

- Lamps counter 1 (see page 9);
- Lamps counter 2 (see page 9);
- Lamps counter 3 (see page 10);
- Fans counter (see page 10);
- Time delays counter (see page 11);
- Paid time counter (see page 11);
- Clients counter (see page 12);
- Electric energy counter (see page 12);
- Takings total counter (see page 13).

Range of setting: no - counter deactivated;
yes - counter activated
Default setting: no



Counters activated in the *No code access* submenu are available in the *Counters presentation* submenu (see page 7). In the *Counters presentation* submenu it is only possible to browse the counter's contents, without the possibility of deleting their contents.

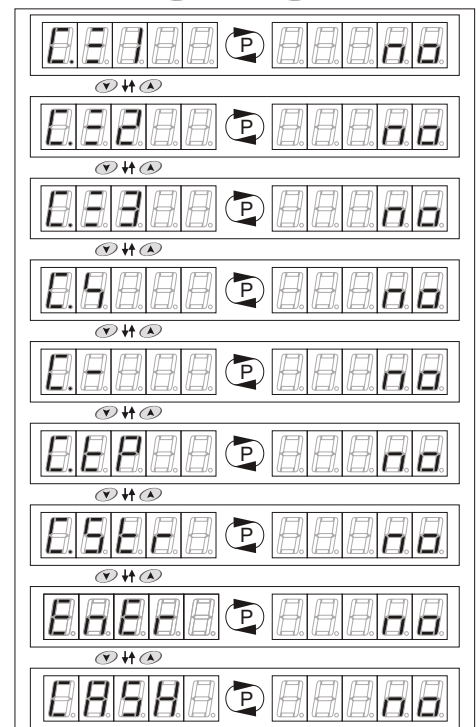

Part II Operating manual

2. Programming mode

To access *No code access* submenu:

1. When the controller is in the programming mode (see page 5), in the *Protected settings* submenu (see page 7), select *No code access* submenu with and buttons.

2. Press button.

To browse and/or change accessibility of the counters:

1. When the controller is in the programming mode (see page 5), in the *No code access* submenu, select the counter with and buttons. The selected counter symbol and the selected counter setting is displayed alternately.

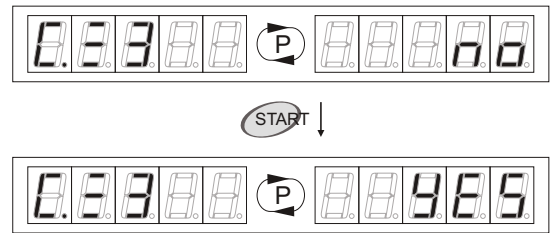

2. To change the accessibility of the selected counter, press button. The selected counter symbol and the selected counter new setting is displayed alternately.

To return to the *Protected settings* submenu, press button. To leave the programming mode and save new setting in the long term memory, press button or wait 60 seconds.

Code change

All new controllers have producer's code (00000). To enable access of the unauthorized people to the *Protected settings* submenu (see page 7), it is recommended that the code should be changed by the user.

Range of setting: 5 numbers

Default setting: 00000

Available numbers:

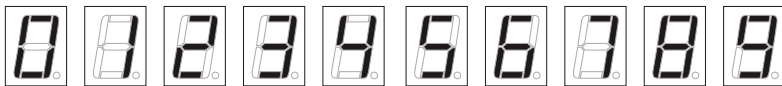

To change code:

1. When the controller is in the programming mode (see page 5), in the *Protected settings* submenu (see page 7), select *Code* submenu with and buttons.

2. Press button. will be displayed for a while. Enter new code with and buttons, confirming each selected number with button. After confirming fifth number, will be displayed for a while. Enter new code again with and buttons, confirming each selected number with button. will be displayed for a while.

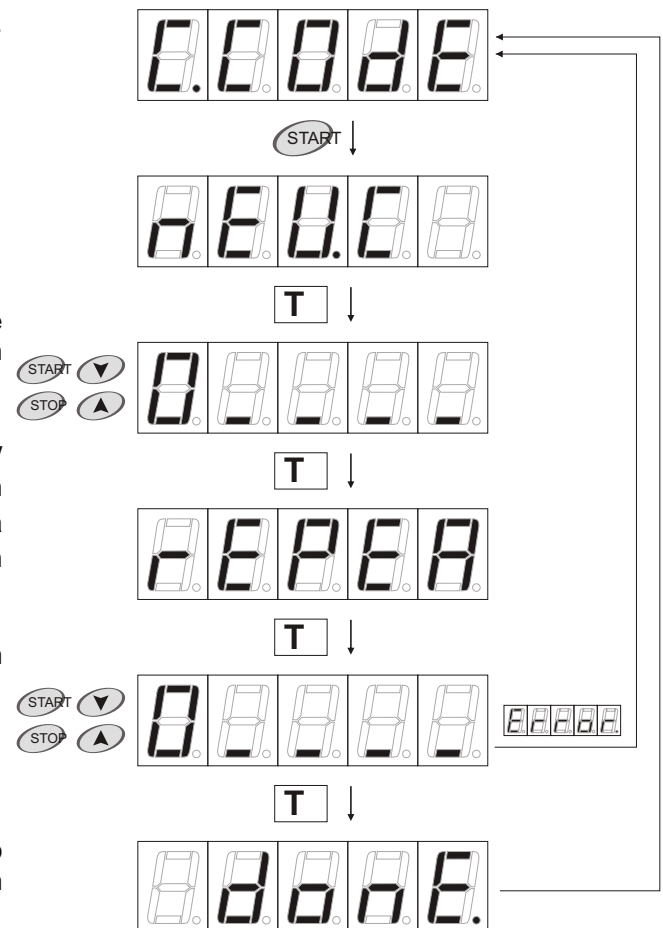

New code is saved automatically in the long term memory, after confirming fifth number with button.

Pressing button causes previous number reedition.

To return to the *Protected settings* submenu, press button. To leave the programming mode and save new setting in the long term memory, press button or wait 60 seconds.